

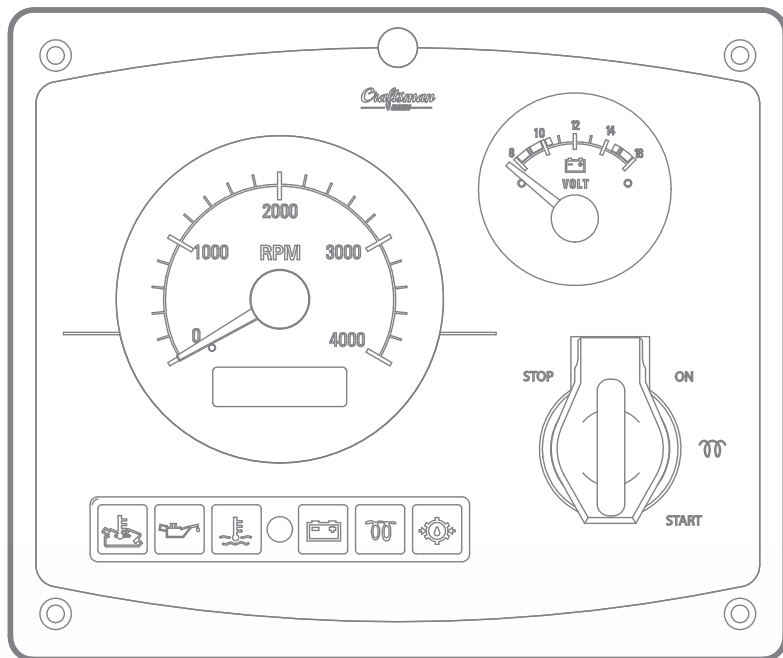

Craftsman
MARINE



ALFA 10E 30E 20E 40E

INSTRUMENT PANEL MANUAL

CRAFTED WITH CRAFTSMAN MARINE

PROPULSION

The specifications and descriptions in this manual have been entirely correct at the moment of going to press. However, Craftsman Marine is always in pursuit of continuous improvement of its products and reserves the right to modify product specifications and instruction manuals at any given moment, without prior notice.

This page will provide you with a survey of all warning pictograms, used throughout this manual. Notes referring to safety issues show this symbol:



DANGER ATTENTION

Please adhere strictly to the recommendations in this chapter and instruct anybody else, who may be operating or servicing the engine, to do likewise. These are the safety recommendations:

- When the engine is in operation: do not touch any of the moving parts.
- When the engine is in operation several components will become very hot. Never touch these parts and avoid the use of flammable products in the vicinity of the engine.
- In the case of adjustment or inspection of parts of the engine and when filling in lubrication oil or cooling liquid, the engine must be stopped and cooled down.
- Never open the cap of the expansion tank of the cooling liquid when the engine is not entirely cooled down.
- All maintenance jobs should be executed by qualified mechanics, using properly fitting tools.

If at all possible, only entrust these jobs to an authorized Craftsman Marine dealer.



Pay attention to the symbols and read the instructions in the text.







Attention
(especially with a view to a safety risk for man or material)

Table of contents

Disclaimer	2	6 Operation	15
Safety	2	Starting the engine	15
		Stopping the engine	15
1 Specifications of the engine control/ instrument panels	4	7 Engine configurations	16
Monitoring lights	4	CM2.12 / CM2.16	16
Scope of supply includes as well	4	CM3.27	17
		CM4.33 / CM4.42	18
2 Functions of the engine control/instrument panel	5	8 Alternative possibilities	20
		Replacement of standard control/instrument panel	20
3 Product survey	6	Replace engine control/instrument panel of a CM4.33 or CM4.42 engine	22
4 Installation	8	Extension of the ALFA20E panel with a temperature gauge	23
5 Settings	11	9 Electrical wiring diagrams	24
I – Calibration of the revolution counter	11	10 Drilling pattern / principal dimensions	30
A. Fine-tuning (direct setting)	11		
B. Adjust (adjustment via menu)	11		
C. Pulse- (adjustment via menu)	11		
II – Background lightning	12		
A. Potentiometer	12		
B. Craftsman Marine automatic dimmer module	13		
III – Pre-heating relay	14		

1 Specifications of the engine control/instrument panels

Description	ALFA10E	ALFA20E	ALFA30E	ALFA40E
				
Monitoring lights				
- high exhaust temperature	•	•	•	•
- low oil pressure in engine	•	•	•	•
- high cooling liquid temperature	•	•	•	•
- charging current of the battery	•	•	•	•
- pre-heating of the engine	•	•	•	•
- low oil pressure in the gearbox	-	optional	optional	optional
Acoustic alarm (buzzer)	•	•	•	•
Starter switch (pre-heating by hand)	•	•	•	•
Automatic pre-heating	optional	optional	optional	optional
Revolution counter/ Hour counter	-	•	•	optional
Voltmeter	-	•	•	optional
Temperature gauge	-	optional *1	•	optional
Oil pressure gauge	-	-	•	optional
Automatic dimmer (max. 20W)	-	optional	optional	optional
Supply voltage	12 V	12 V	12 V	12 V
Scope of supply includes as well:				
- Gasket under fitting edge	•	•	•	•
- 4 fixing screws	•	•	•	
- Cover for starter switch	•	•	•	•
- 3 keys	•	•	•	•
Panel dimensions [mm]	100 x 166	198 x 166	260 x 166	150 x 50
Build-in dimensions [mm]	76 x 138	175 x 143	237 x 143	102 x 34
Build-in depth [mm]	114	114	114	114
Distance of fastening holes [mm]	75 x 142	174 x 142	236 x 142	124

*1 in lieu of the volt meter

Functions of the engine control/instrument panel 2

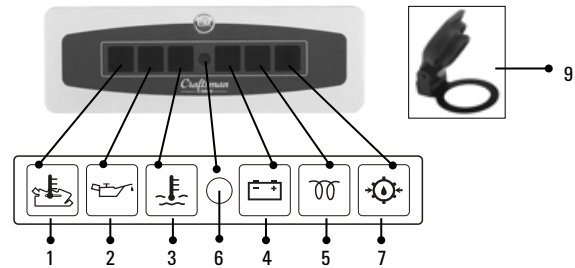
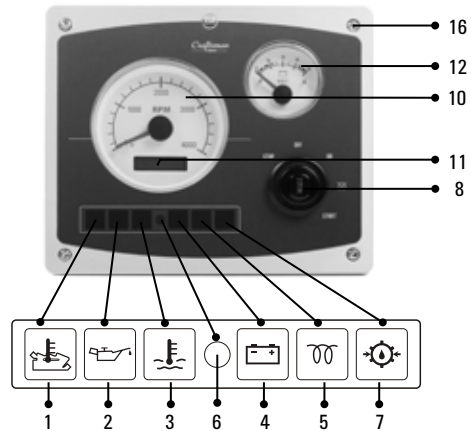
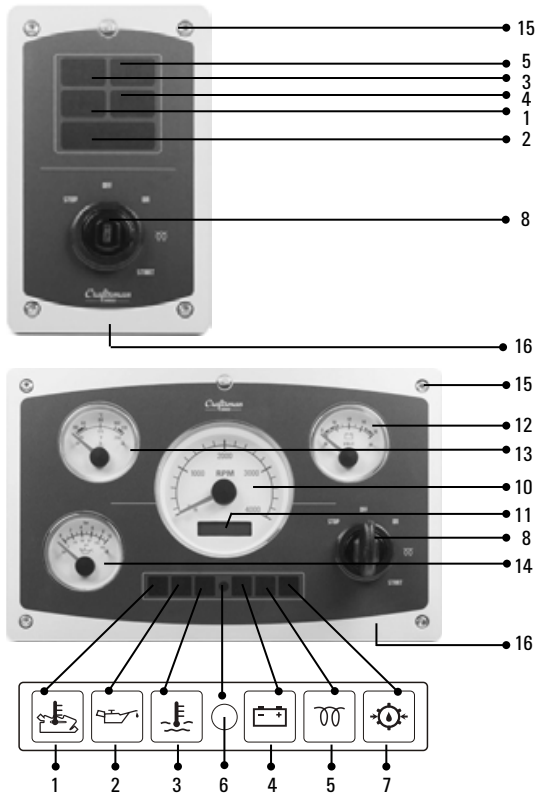









1. Alarm high exhaust temperature (raw water cooling circuit)
2. Alarm low oil pressure in engine
3. Alarm high temperature of cooling liquid (internal cooling circuit)
4. Alarm charging current of the battery
5. Pre-heating
6. Sensor for automatic dimmer of lighting
7. Alarm low oil pressure in gearbox (optional)
8. Starter switch

9. Cover for starter switch
10. Revolution counter
11. Hour counter
12. Voltmeter
13. Temperature gauge (internal cooling circuit)
14. Oil pressure gauge of the engine
15. Fixation holes
16. Gasket (for use below fitting edges at rear of panel)

3 Product survey

Type of engine control panel						
Article code	AB.010.20000	AB.020.20000	AB.020.20001	AB.030.20000	AB.030.20001	AB.040.20000
Description	Engine control panel ALFA10E	Engine control panel ALFA 20E with black dial instruments	Engine control panel ALFA 20E with white dial instruments	Engine control panel ALFA 30E with black dial instruments	Engine control panel ALFA 30E with white dial instruments	Engine control panel ALFA40E

Type of cable					
Article code	AB.050.20002	AB.050.20004	AB.050.20006	AB.050.20010	
Description	Connection cable for engine control panel 2m, type A	Connection cable for engine control panel 4m, type A	Connection cable for engine control panel 6m, type A	Connection cable for engine control panel 10m, type A	

Type of cable					
Article code	AB.050.21002	AB.050.21004	AB.050.21006	AB.050.21010	
Description	Connection cable for engine control panel 2m, type B	Connection cable for engine control panel 4m, type B	Connection cable for engine control panel 6m, type B	Connection cable for engine control panel 10m, type B	

Type of switch / sensor					
Article code	DB.020.20001				
Description	KIT: Oil pressure switch/ sensor, 0.49bar/0-8bar, adapter				

Type of switch / sensor					
Article code	DB.020.20002				
Description	Temperature switch/sensor, 105 °Celsius /40-120 °Celsius				

Type of sensor					
Article code	DB.020.20003				
Description	Temperature sensor 40-120° Celsius				

4 Installation

Engine control/ instrument panel

1. Determine the correct position for the panel, in a place where the skipper has a clear survey of the panel and where no heavy vibrations can occur.
2. If the control panel is fitted outside, the cover for the starter switch must be fitted too, so as to avoid dirt and (sea) water entering into the switch. Only the top side of the panel is watertight.
3. Cut out a hole into the steering stand with the aid of the supplied drilling pattern.
4. Position the gasket at the bottom of the panel; a recess to receive the gasket is provided all around in the edge.
5. Connect the extension cables type A and B with the engine control/instrument panel.
6. Fit the panel with the aid of the 4 screws and plastic washers, supplied.

Cover (see pictures below)

1. Remove the plastic ring
2. Remove the nut
3. Position the cover
4. Fit the nut and the cover

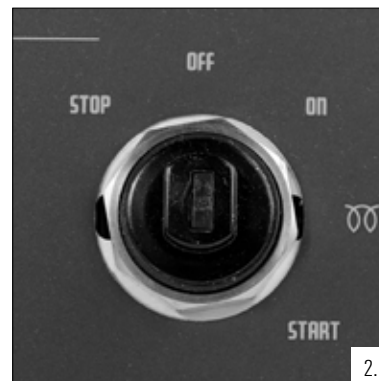
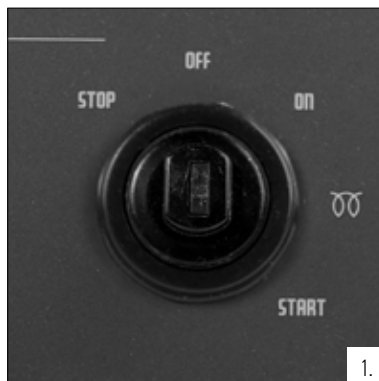

Engine control/instrument panel ALFA40E

Fix the position of the panel at the rear with the aid of the bracket supplied.

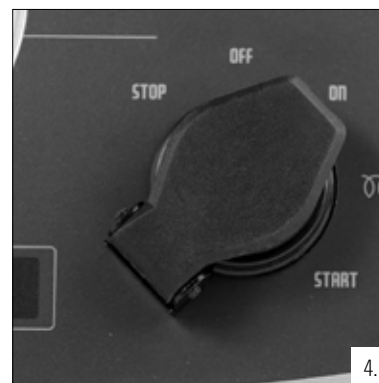
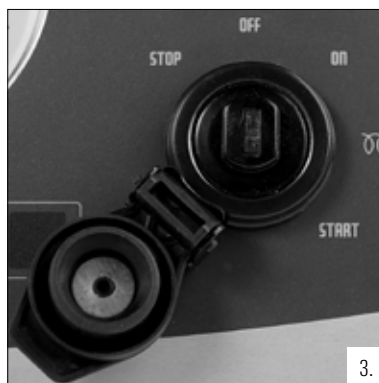

Engine control/instrument panel type ALFA40E

The engine control panel type ALFA40E features 3 plugs which must be connected as follows: (see picture 5)

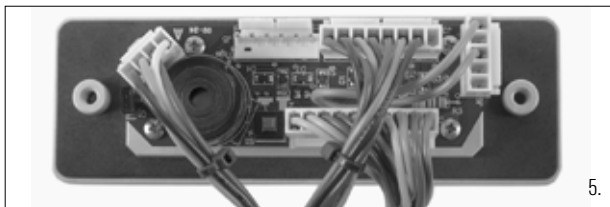

Following instruments or switches can be connected onto the control panel type ALFA40E:

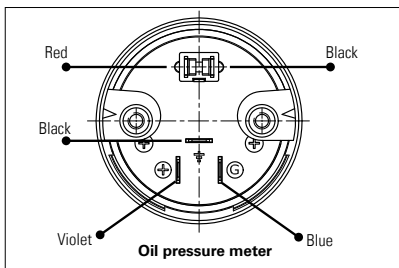

Connections of the oil pressure gauge

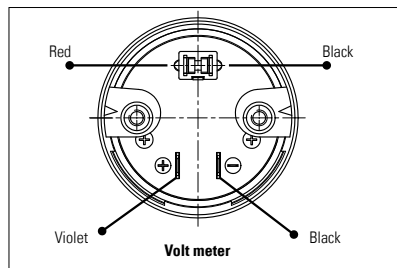

Connections of the volt meter

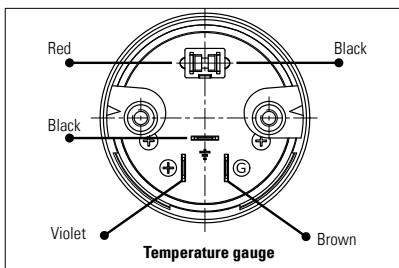

Connections of the temperature gauge



Connections of the revolution counter



Connections of starter switch

Notes

A series of horizontal dotted lines for writing notes, arranged in two columns.

I – Calibration of the revolution counter

In order to achieve the correct indication of the revolution counter, this instrument must be calibrated with the engine. Please take following steps:

1. This work can best be done by 2 persons.
2. Measure the number of engine revolutions with a manual revolution counter at the crank shaft.
3. Set the engine at 2000 revolutions.
4. As soon as the manual revolution counter indicates 2.000 revs, adjust the revolution counter in the instrument panel accordingly.

The revolution counter can be calibrated by 3 methods (A, B or C). Select your most convenient method:

A. Fine-tuning (direct setting)

This method allows for an adjustment of -20% to +20% as opposed to the factory setting.

When the engine is in operation:

1. Keep the button at the back of the revolution counter depressed, in order to increase the indication figure.
2. If the button is released and kept depressed thereafter, the indication figure of the revolution counter will be decreased.
3. Adjust the number of revolutions of the revolution counter in the panel by the same value as indicated by the manual revolution counter.

B. Adjust (adjustment via menu)

This method allows for adjustment if the indication is within the bracket between 30% en 100% (1200-4000 rpm)

When the engine is in operation:

1. Keep the button at the back of the revolution counter depressed and position the starter switch in the "ON" position.
2. The display will now show the text PULSE or ADJUST.
3. Push the button until the word ADJUST will show.

4. Release the push button.
5. Now keep the button at the back depressed in order to raise the indicated number of revolutions.
6. If the button is released and kept depressed thereafter, the indication figure of the revolution counter will be decreased .
7. Adjust the number of revolutions of the revolution counter in the panel by the same value as indicated by the manual revolution counter.
8. Turn the starter switch to the "OFF" position and thereafter to the "ON" position.

C. Pulse - (adjustment via menu)

This method allows for adjustment if it is known how many pulses per revolution are generated by the alternator or the sensor. This method does NOT involve the starting up of the engine.

Action to take:

1. Keep the button at the back of the revolution counter depressed and position the starter switch in the "ON" position.
2. The display will now show the text PULSE or ADJUST.
3. Push the button until the word PULSE will show.
4. Release the push button.
5. The display will now show the number of pulses/revolutions as per the factory setting. Example: 1 2 3 . 4 5
6. Figure 5 will now begin to blink (maximum 3 times). Press the button in order to increase or decrease the figure. At first the values will be increased, thereafter decreased.
7. If you do not react after three times blinking, following figures will start to blink successively: 4, 3, 2 and 1.
8. Adjust with the aid of these figures the required number of pulses/revolutions.
9. After completion of figure 1, the menu will close down automatically. This can also be achieved by cutting off the voltage supply.

5 Settings

II – Background lighting

There are 2 possibilities for dimming the brightness of the background lighting:

1. by using an own type of dimmer of the potentiometer type
2. by using the automatic dimmer module by Craftsman Marine.

A. Potentiometer:

1. Position the battery main switch in the 'OFF' position
2. Remove the plug (A) ; see picture below
3. Cut the wire loop
4. Position the dimmer (B) between the two wire ends
5. Put the plug with the dimmer (A) back into the printed circuit board (position J6)

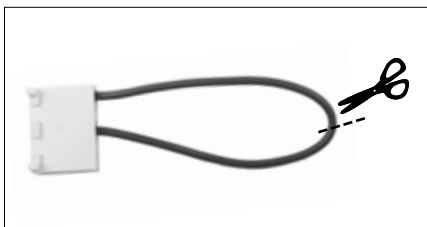
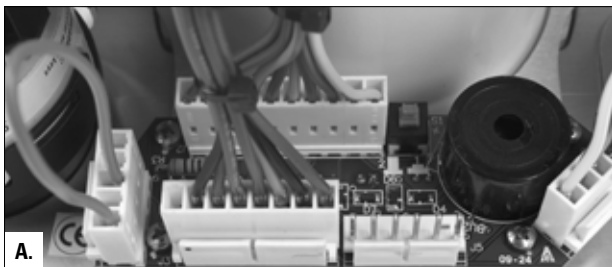

A.

3.

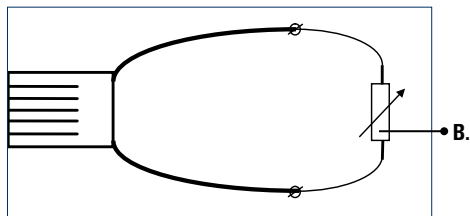

4.

B. Craftsman Marine automatic dimmer module:

1. Position the battery main switch in the "OFF" position
 2. Remove the plug A (see adjacent picture) and replace it by the dimmer module.
- The plug that you have just now removed will no longer be needed.

The functioning of the dimmer module:

As soon as the background lighting will be switched on, the illumination will be dimmed automatically, in accordance with the night getting darker. The dimmer module is suitable for maximum 20W.

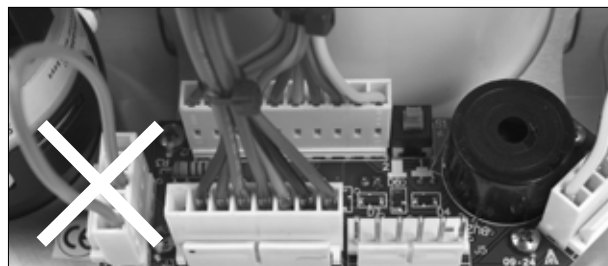
**A.****Through-connection of the lighting:**

If, in addition to the main instrument panel, other instruments will be placed and connected, such as, e.g., a Craftsman Marine fuel gauge, (waste) water gauge, temperature gauge or oil pressure gauge, the lighting thereof can also be switched on or off, or dimmed, through the engine instrument panel.

The instruments must be connected in the following manner:

The background lighting of the panels ALFA20E and ALFA30E is furnished with dual plugs. Through this connecting point a connection can be made to another instrument; see adjoining picture.

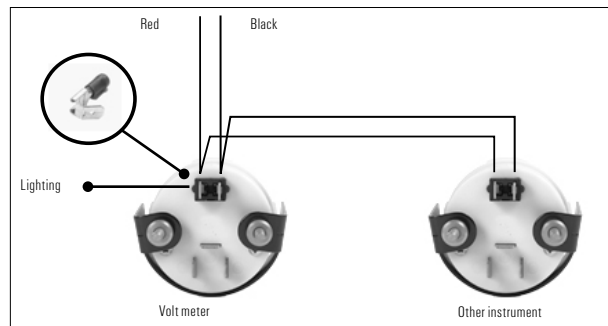

5 Settings

III - Pre-heating relay

The engine may be equipped with either a hand-operated pre-heating relay, or an automatic one. In the latter case, the starter switch does not show a pre-heating position.

Dependent on the type of pre-heating relay, the panel must be adjusted to it. Please see picture below for the switch setting.

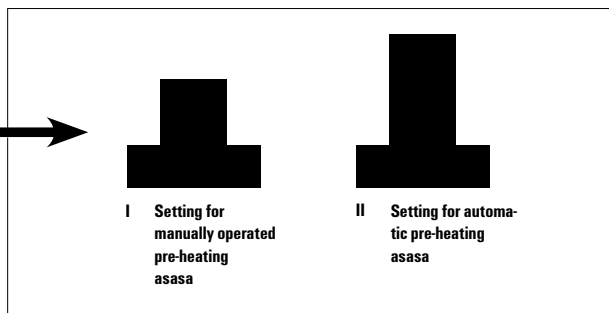
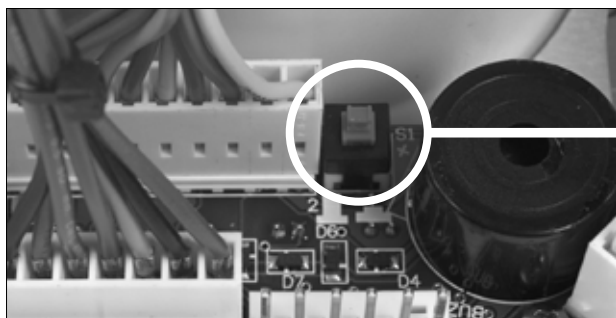

The standard factory setting is 'I' (manual pre-heating, switch depressed).

Only modify the setting if you are absolutely sure that the engine is provided with an automatic pre-heating relay and the correct type of starter switch.

Operation of the control panel

Starting the engine:

1. Before starting up the engine, always verify the following:

- level of lubrication oil
- level of cooling liquid (internal cooling circuit)
- whether the seacock for the entry of raw cooling water is in the open position
- whether the main battery switch is switched on
- whether the gearbox is in the neutral position

2. From the 'OFF' position, turn the starter key one position to the right, to the 'ON' position.

The monitoring lights for oil pressure and current charging will light up and the buzzer sounds.

3. Pre-heating:

Pre-heating, only if required; please see your engine instruction manual.

Pre-heating by hand:

- Now turn the switch to the pre-heating position and keep it there. The pre-heating monitoring light will light up. The time involved in keeping the switch in the pre-heating position is dependent on the type of engine. Please see the relevant engine instruction manual

Automatic pre-heating (optional):

- Place the starter switch in the ON position. The pre-heating indicator on the instrument panel will light up.
- Wait with the starting procedure until this monitoring light is extinguished.

4. Thereafter turn the switch further to the right, to the 'START' position.

Release the key as soon as the engine springs to life; the key will return automatically to the 'on' position, where it will remain parked as long as the engine is in operation.



Stop the starting procedure if the engine does not respond within a period of 10 seconds. Release the key and wait till the starter motor has come to a complete stand-still before giving it another try. Never have the starter motor working for more than 30 seconds continuously, so as to avoid damage by overheating.



5. Verify that the monitoring lights of oil pressure and charging current are extinguished and make sure that the raw cooling water is streaming out of the exhaust. If this is not the case, then turn off the engine IMMEDIATELY.



Never turn the main battery switch to the 'off' position when the engine is running. Never turn the starter switch to the 'start' position when the engine is running, so as to avoid serious damage to the starter motor.

Stopping the engine:

Have the engine running at idling speed for a few moments. Switch the gearbox into its neutral position and turn the key to the far left, to the 'STOP' position. Then turn the key one position to the right, to the 'OFF' position, when the engine has stopped.

Standard:



ALFA10E

Optional:



ALFA20E



ALFA30E



ALFA40E

Standard: Volt meter
Optional: Temperature gauge

AB.050.20002	Connection cable engine panel 2m, type A
AB.050.20004	Connection cable engine panel 4m, type A
AB.050.20006	Connection cable engine panel 6m, type A
AB.050.20010	Connection cable engine panel 10m, type A

AB.050.21002	Connection cable engine panel 2m, type B
AB.050.21004	Connection cable engine panel 4m, type B
AB.050.21006	Connection cable engine panel 6m, type B
AB.050.21010	Connection cable engine panel 10m, type B

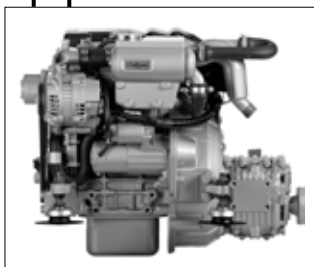

	DB.020.20002	Temperature switch/sensor 105 degrees/40-120 degrees	Optional *1: ALFA20E + temperature gauge
	DB.020.20001	KIT Oil pressure switch/sensor, 0.49 bar/0-8 bar	Optional *2: ALFA30E + ALFA40E

*1: The temperature switch in the engine must be replaced by the temperature switch/sensor

*2: The oil pressure switch in the engine must be replaced by the oil pressure switch/sensor

Standard:



ALFA20E

Optional:



ALFA30E





ALFA40E

Standard: Volt meter
Optional: Temperature gauge

AB.050.20002	Connection cable engine panel 2m, type A
AB.050.20004	Connection cable engine panel 4m, type A
AB.050.20006	Connection cable engine panel 6m, type A
AB.050.20010	Connection cable engine panel 10m, type A

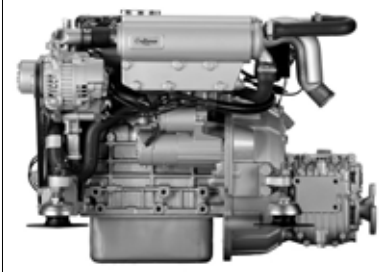
AB.050.21002	Connection cable engine panel 2m, type B
AB.050.21004	Connection cable engine panel 4m, type B
AB.050.21006	Connection cable engine panel 6m, type B
AB.050.21010	Connection cable engine panel 10m, type B



	DB.020.20002	Temperature switch/sensor 105 degrees/40-120 degrees	Optional *1: ALFA20E + temperature gauge
	DB.020.20001	KIT Oil pressure switch/sensor, 0.49 bar/0-8 bar	Optional *2: ALFA30E + ALFA40E

*1: The temperature switch in the engine must be replaced by the temperature switch/sensor
 *2: The oil pressure switch in the engine must be replaced by the oil pressure switch/sensor

Standard:



ALFA20E

Optional:



ALFA30E





ALFA40E

Standard: Volt meter
Optional: Temperature gauge

AB.050.20002	Connection cable engine panel 2m, type A
AB.050.20004	Connection cable engine panel 4m, type A
AB.050.20006	Connection cable engine panel 6m, type A
AB.050.20010	Connection cable engine panel 10m, type A

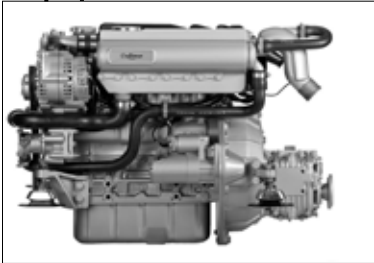
AB.050.21002	Connection cable engine panel 2m, type B
AB.050.21004	Connection cable engine panel 4m, type B
AB.050.21006	Connection cable engine panel 6m, type B
AB.050.21010	Connection cable engine panel 10m, type B



	DB.020.20003	Temperature sensor 40-120 degrees	Optional *1: ALFA20E + temperature gauge
	DB.020.20001	KIT Oil pressure switch/sensor, 0.49 bar/0-8 bar	Optional *2: ALFA30E + ALFA40E

*1: The temperature switch in the engine must be replaced by the temperature switch/sensor

*2: The oil pressure switch in the engine must be replaced by the oil pressure switch/sensor

.....

.....

.....

.....

.....

.....

.....

.....

.....

.....

.....

.....

.....

.....

.....

8 Alternative possibilities

Survey of extension possibilities of the control panels and the sensors required:

Engine type	Standard supply	ALFA20E with volt meter	ALFA20E with temperature gauge	ALFA30E / ALFA40E
CM2.12, CM2.16	ALFA10E	No extra sensors required	Sensor: DB020.20002	Sensor: DB020.20002 DB020.20001
CM3.27	ALFA20E (with volt meter)	-	Sensor: DB020.20002	Sensor: DB020.20002 DB020.20001
CM4.33, CM4.42	ALFA20E (with volt meter)	-	Sensor: DB020.20003	Sensor: DB020.20003 DB020.20001

Replacement of standard control/instrument panel

(with CM2.12, CM2.16 & CM3.27 engines)

I a - CM2.12, CM2.16 en CM3.27 with an ALFA20E panel + temperature gauge

Following must be done to connect an ALFA20E panel to the engine models CM2.12, CM2.16 or CM3.27:

1. Remove the temperature switch (see the adjoining picture)
2. Fit instead the temperature switch/sensor type DB.020.20002
3. The wiring features 2 plugs: one for the temperature switch and the other one for the temperature sensor. Connect these plugs as indicated with the adjoining picture.
4. Remove the ALFA10E panel.
5. Install instead the ALFA20E panel and fit the temperature gauge.

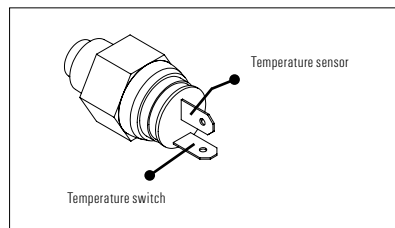
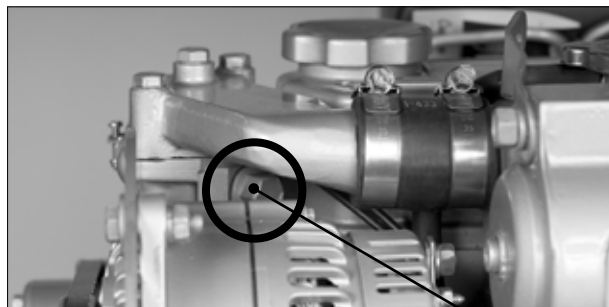

N.B.: the engine models CM2.12, CM2.16 / CM3.27 have a switch instead of the plug!

I b - CM2.12, CM2.16 and CM3.27 with an ALFA30E or ALFA40E control/instrument panel

Following must be done to connect an ALFA20E panel to the engine models CM2.12, CM2.16 or CM3.27:

1. Follow the steps 1 to 4, described on the previous page
2. Remove the oil pressure switch (see the adjoining picture).
3. Fit instead the adapter and the oil pressure switch / sensor type DB.020.20001
4. The wiring features 2 plugs: one for the oil pressure switch and the other one for the oil pressure sensor. Connect these plugs as indicated in the picture below.
5. Remove the ALFA10E or ALFA20E panel
6. Fit instead the ALFA30E or ALFA40E panel

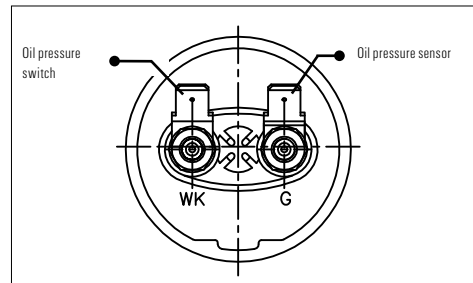
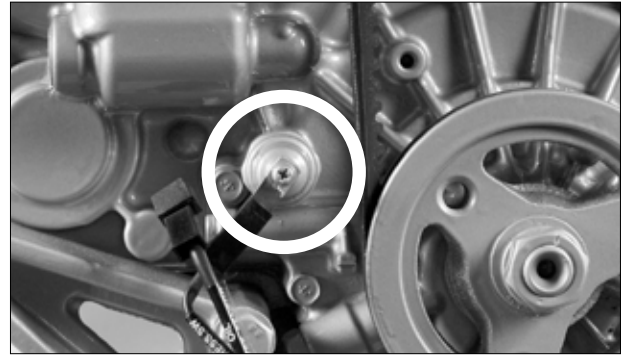

8 Alternative possibilities

Replace engine control/instrument panel of a CM4.33 or CM4.42 engine

II a - CM4.33 / CM4.42 with an ALFA20E panel + temperature gauge

Following must be done to connect an ALFA20E panel to the engine models CM4.33 and CM4.42:

1. Remove the plug from the thermostat housing (see adjoining picture)
2. Fit instead the temperature sensor type DB.020.20003
3. The wiring features two plugs: one for the temperature switch (already fitted) and the other one for the temperature sensor. Connect this plug to the temperature sensor.
4. Fit the temperature gauge, as per description on page 23.

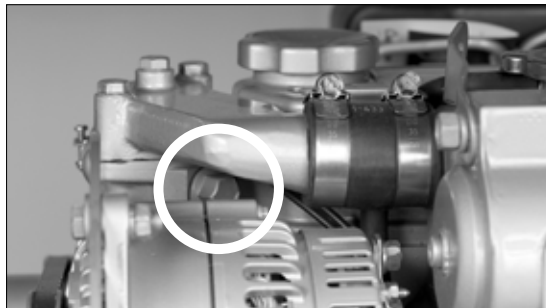

II b - CM4.33 / CM4.42 with an ALFA30E or ALFA40E control/instrument panel

Following must be done to connect an ALFA30E or ALFA40E panel to the engine models CM4.33 and CM4.42:

1. Follow the steps 1 to 3, described here above
2. Remove the oil pressure switch (see adjoining picture)
3. Fit instead the adapter and the oil pressure switch/sensor type DB.020.20001
4. Remove the ALFA20E panel
5. Fit instead the ALFA30E or ALFA40E panel

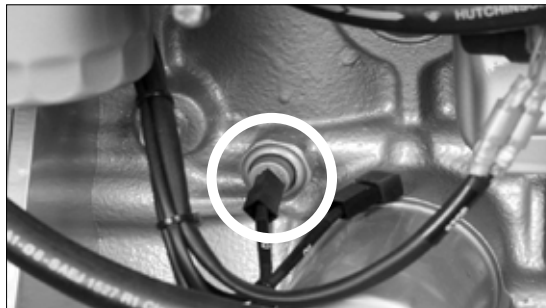

Extension of the ALFA20E panel with a temperature gauge

Following must be done to replace the voltmeter in the ALFA20E panel by a temperature gauge. If so required, the temperature gauge may also be positioned next to the panel.

1. Remove the connecting plugs from the voltmeter.
2. Remove the voltmeter by loosening the bracket (see picture A.)
3. Remove the finishing ring from the temperature meter, by turning it anti-clockwise (see picture B). Make sure that the glass will stay in place.
4. Fit the temperature gauge and fix it with the bracket
5. Fit the plug of the background lighting.
6. Fit the plug of the temperature gauge (brown wire, to the rear of the wiring), see picture C.

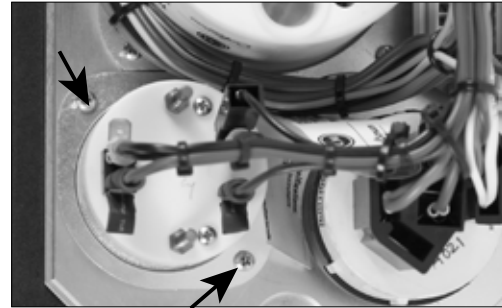

A.



B.

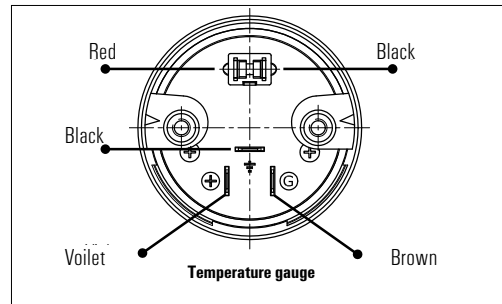

C.

9 Electrical wiring diagrams

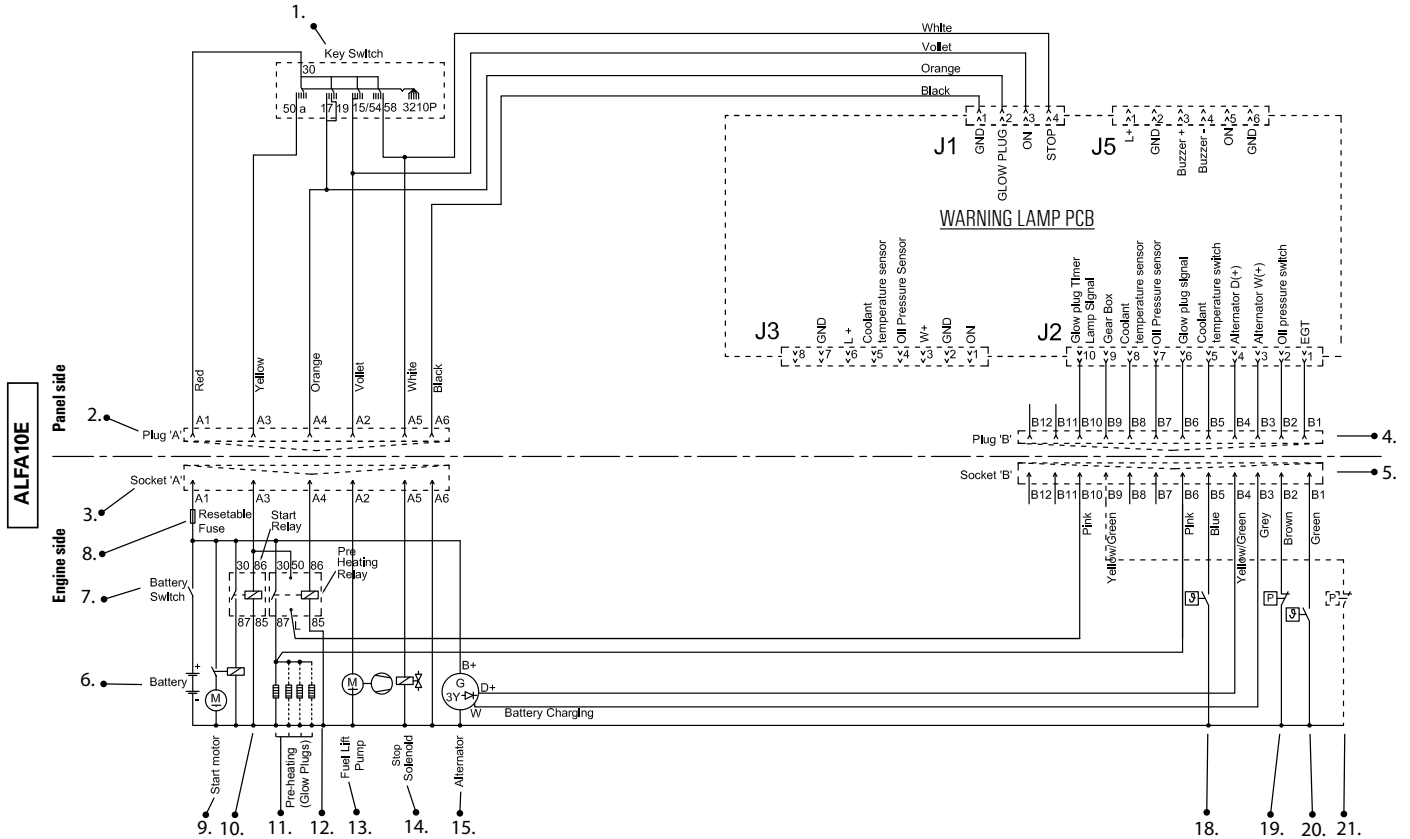

Explanation wiring diagram

A1	Red
A2	Violet
A3	Yellow
A4	Orange
A5	White
A6	Black
B1	Green
B2	Brown
B3	Grey
B4	Yellow/green
B5	Blue
B6	Pink
B7	Blue
B8	Brown
B9	Yellow/green
B10	Pink
B11	Not connected
B12	Not connected
J1	Plug for starter switch
J2	Plug for alarms
J3	Plug for monitoring instruments *1
J5	Plug for external buzzer
J6	Plug for dimmer module *1
1	Starter switch
2	Plug engine control panel type A
3	Plug engine extension cable type A

4	Plug engine control panel type B
5	Plug engine extension cable type B
6	Battery
7	Battery main switch
8	Automatic fuse
9	Starter motor
10	Starter relay
11	Pre-heating plug
12	Pre-heating relay
13	Fuel lift pump (ETR = energized to run)
14	Stop solenoid (ETS = energized to stop)
15	Alternator
16	Sensor cooling liquid temperature *1
17	Sensor oil pressure engine *1 *2
18	Switch cooling liquid temperature
19	Switch oil pressure engine
20	Switch exhaust temperature
21	Switch oil pressure in gearbox *1
22	Voltmeter *1
23	Revolution counter/hour counter *1
24	Oil pressure gauge *1 *2
25	Temperature gauge *1 *3

*1: not for ALFA10E

*2: not for ALFA 20E

*3: optional for ALFA20E

9 Electrical wiring diagrams

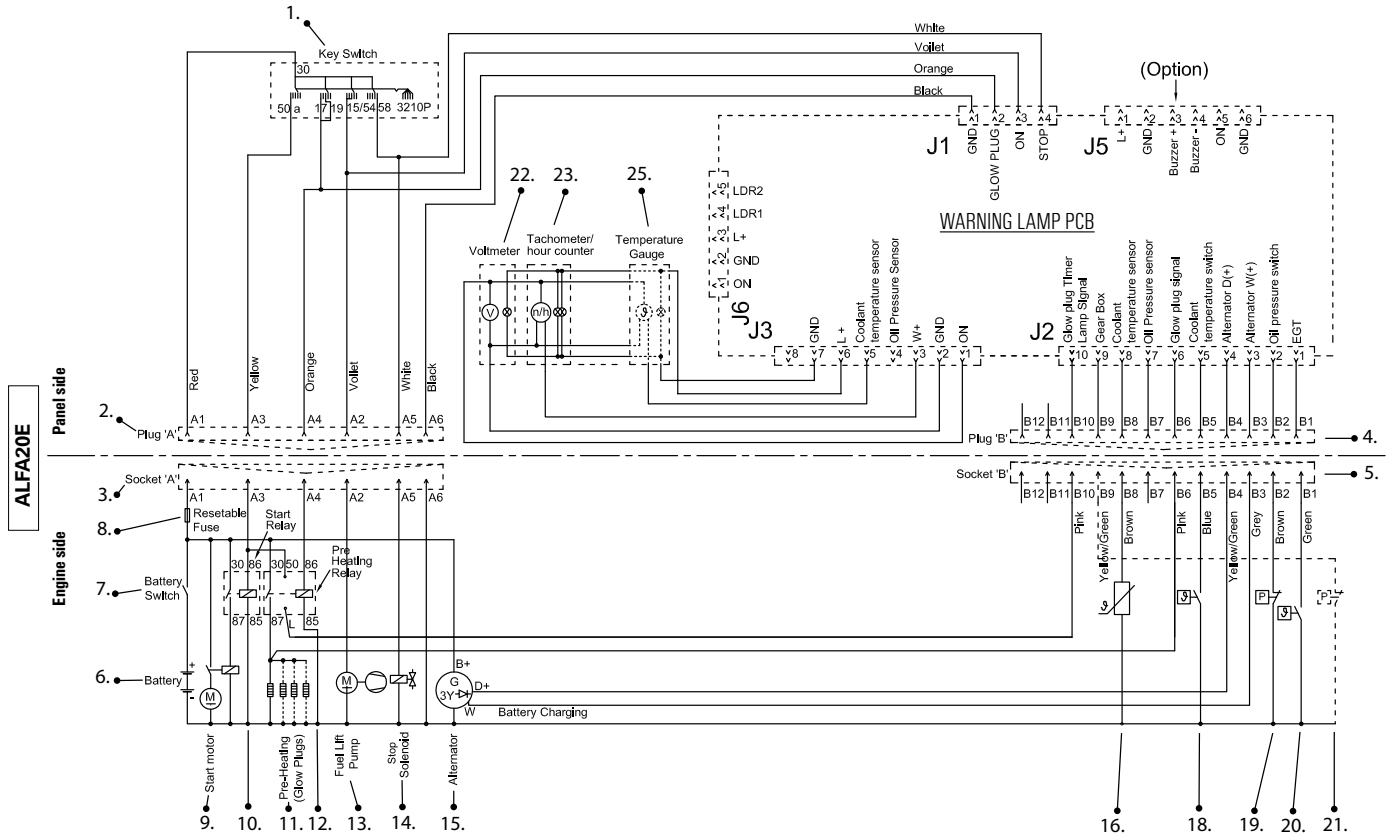

Explanation wiring diagram

A1	Red
A2	Violet
A3	Yellow
A4	Orange
A5	White
A6	Black
B1	Green
B2	Brown
B3	Grey
B4	Yellow/green
B5	Blue
B6	Pink
B7	Blue
B8	Brown
B9	Yellow/green
B10	Pink
B11	Not connected
B12	Not connected
J1	Plug for starter switch
J2	Plug for alarms
J3	Plug for monitoring instruments *1
J5	Plug for external buzzer
J6	Plug for dimmer module *1
1	Starter switch
2	Plug engine control panel type A
3	Plug engine extension cable type A

4	Plug engine control panel type B
5	Plug engine extension cable type B
6	Battery
7	Battery main switch
8	Automatic fuse
9	Starter motor
10	Starter relay
11	Pre-heating plug
12	Pre-heating relay
13	Fuel lift pump (ETR = energized to run)
14	Stop solenoid (ETS = energized to stop)
15	Alternator
16	Sensor cooling liquid temperature *1
17	Sensor oil pressure engine *1 *2
18	Switch cooling liquid temperature
19	Switch oil pressure engine
20	Switch exhaust temperature
21	Switch oil pressure in gearbox *1
22	Voltmeter *1
23	Revolution counter/hour counter *1
24	Oil pressure gauge *1 *2
25	Temperature gauge *1 *3

*1: not for ALFA10E

*2: not for ALFA 20E

*3: optional for ALFA20E

9 Electrical wiring diagrams

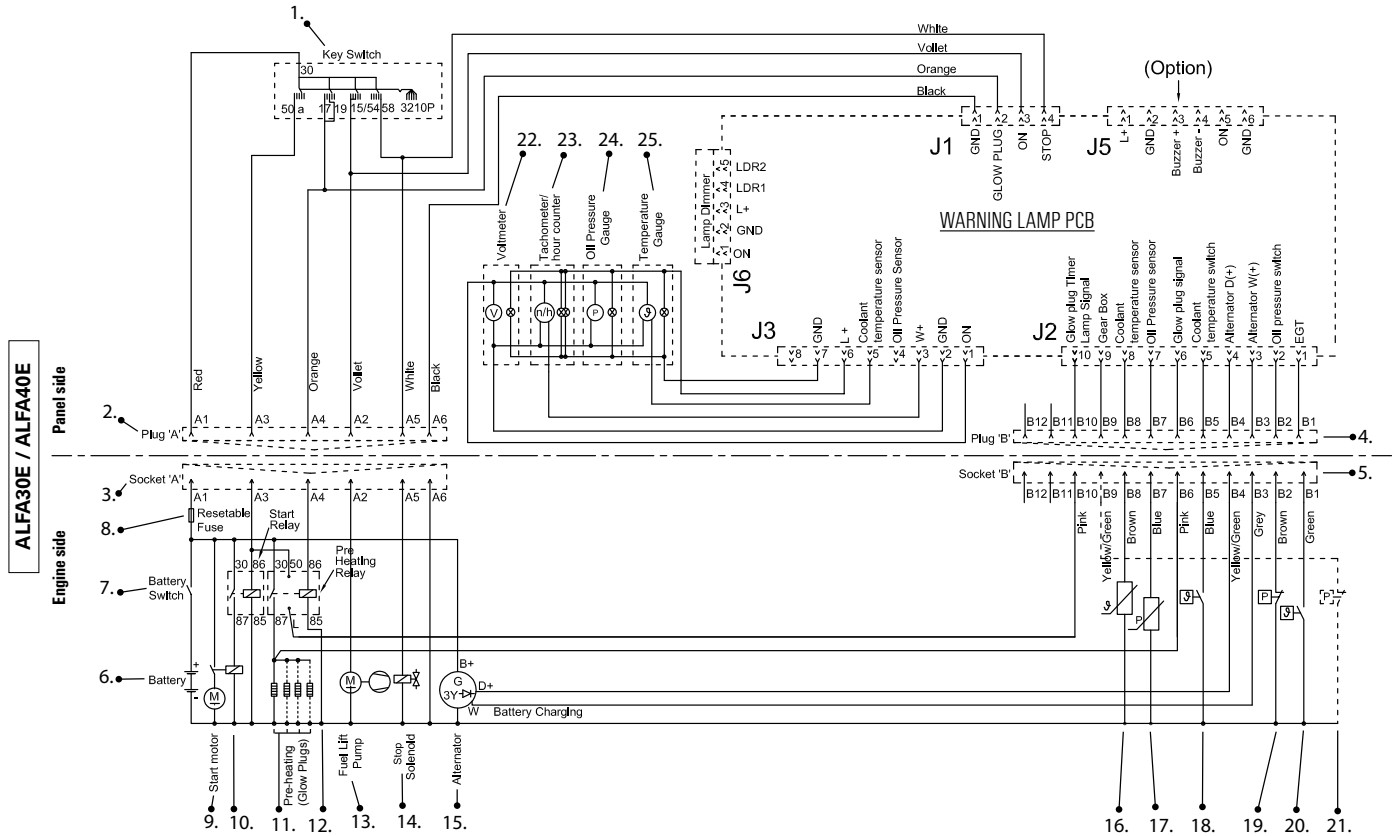

Explanation wiring diagram

A1	Red
A2	Violet
A3	Yellow
A4	Orange
A5	White
A6	Black
B1	Green
B2	Brown
B3	Grey
B4	Yellow/green
B5	Blue
B6	Pink
B7	Blue
B8	Brown
B9	Yellow/green
B10	Pink
B11	Not connected
B12	Not connected
J1	Plug for starter switch
J2	Plug for alarms
J3	Plug for monitoring instruments *1
J5	Plug for external buzzer
J6	Plug for dimmer module *1
1	Starter switch
2	Plug engine control panel type A
3	Plug engine extension cable type A

4	Plug engine control panel type B
5	Plug engine extension cable type B
6	Battery
7	Battery main switch
8	Automatic fuse
9	Starter motor
10	Starter relay
11	Pre-heating plug
12	Pre-heating relay
13	Fuel lift pump (ETR = energized to run)
14	Stop solenoid (ETS = energized to stop)
15	Alternator
16	Sensor cooling liquid temperature *1
17	Sensor oil pressure engine *1 *2
18	Switch cooling liquid temperature
19	Switch oil pressure engine
20	Switch exhaust temperature
21	Switch oil pressure in gearbox *1
22	Voltmeter *1
23	Revolution counter/hour counter *1
24	Oil pressure gauge *1 *2
25	Temperature gauge *1 *3

*1: not for ALFA10E

*2: not for ALFA 20E

*3: optional for ALFA20E

10 Drilling pattern / principal dimensions



Verify all dimensions closely, prior to cutting!
MAKE USE OF SEPARATE A4 SHEETS TO MAKE THE PATTERN!

ALFA10E

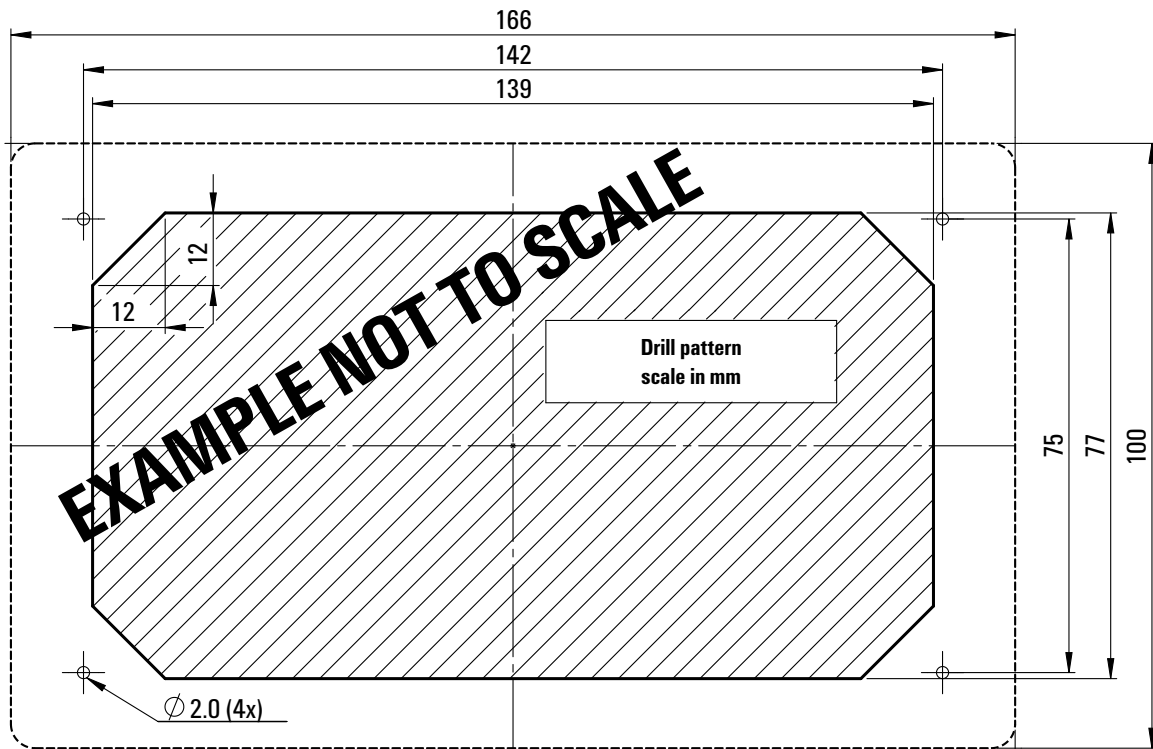



Verify all dimensions closely, prior to cutting!

MAKE USE OF SEPARATE A4 SHEETS TO MAKE THE PATTERN!

ALFA20E

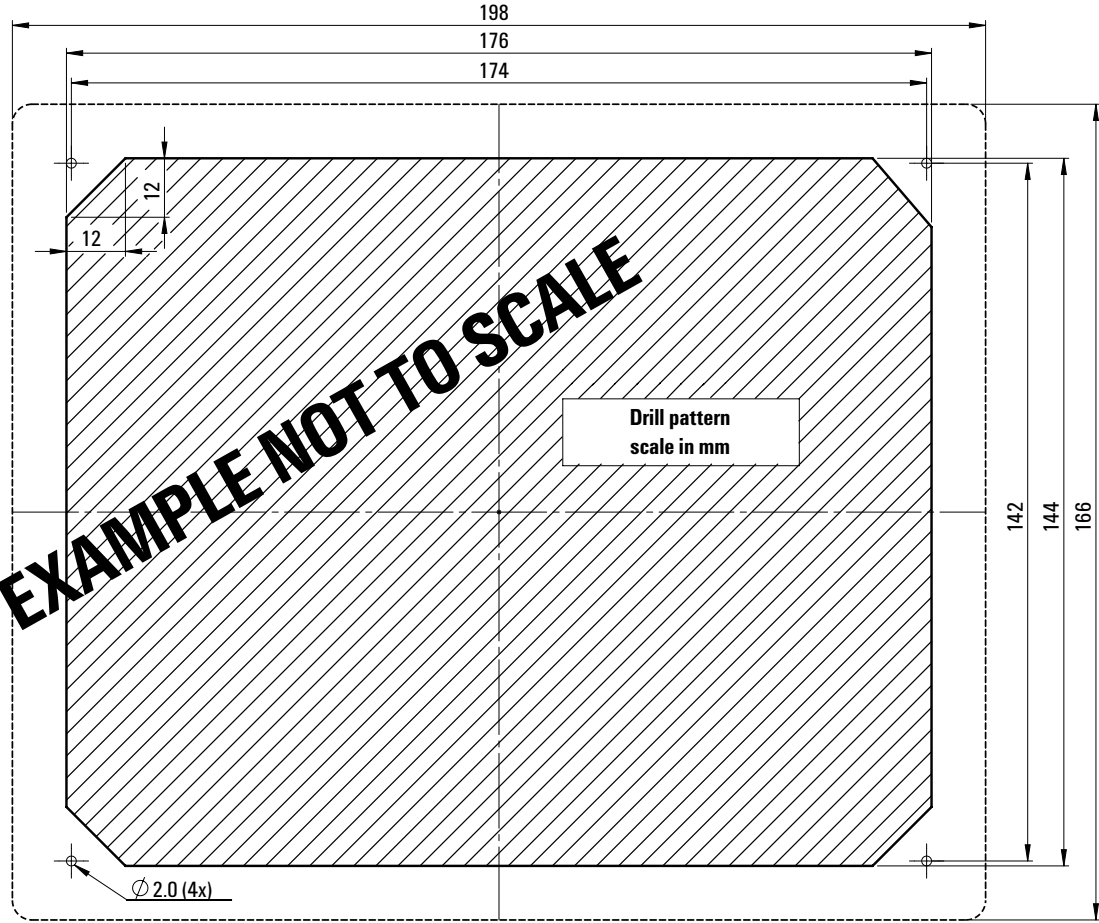

10 Drilling pattern / principal dimensions



Verify all dimensions closely, prior to cutting!

MAKE USE OF SEPARATE A4 SHEETS TO MAKE THE PATTERN!

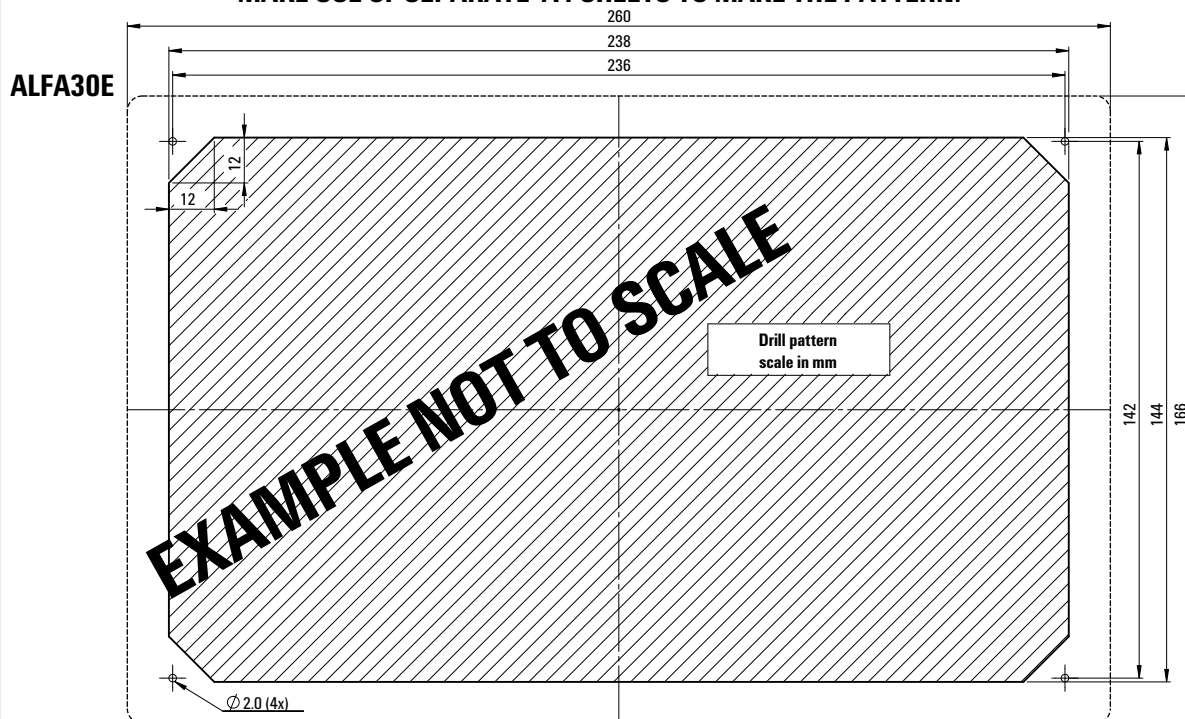

ALFA40E

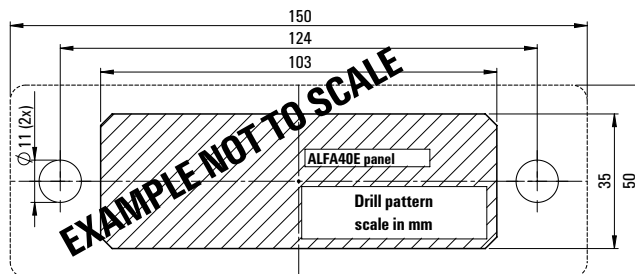

.....

.....

.....

.....

.....

.....

.....

.....

.....

.....

.....

.....

.....

.....

.....

.....

.....

.....

.....

.....

.....

.....

.....

Notes

info@craftsmanmarine.com
www.craftsmanmarine.com

ZD-010-0062.1.10889

CRAFTED WITH CRAFTSMAN MARINE