

Aanzicht Boven

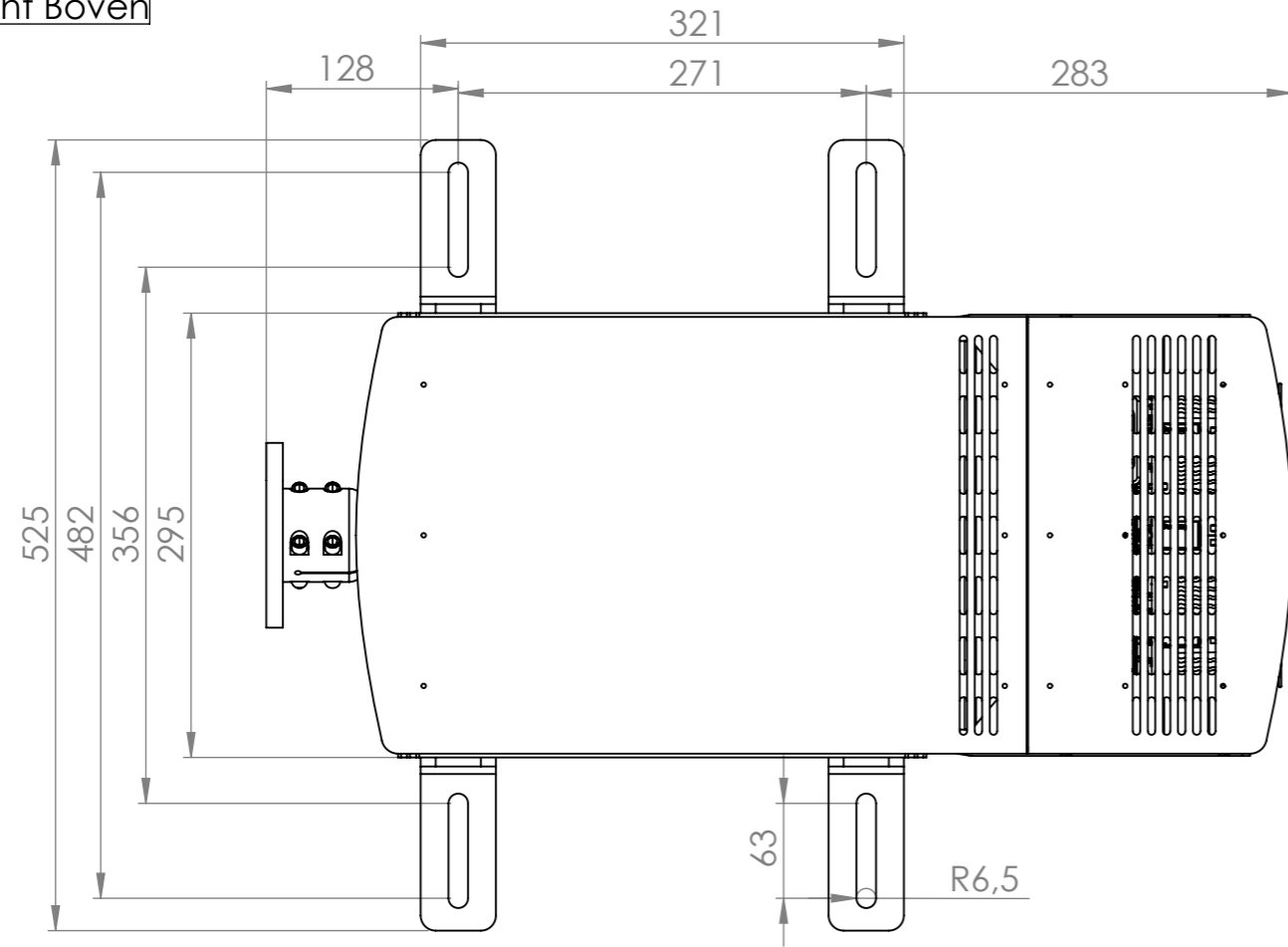

Aanzicht 3D

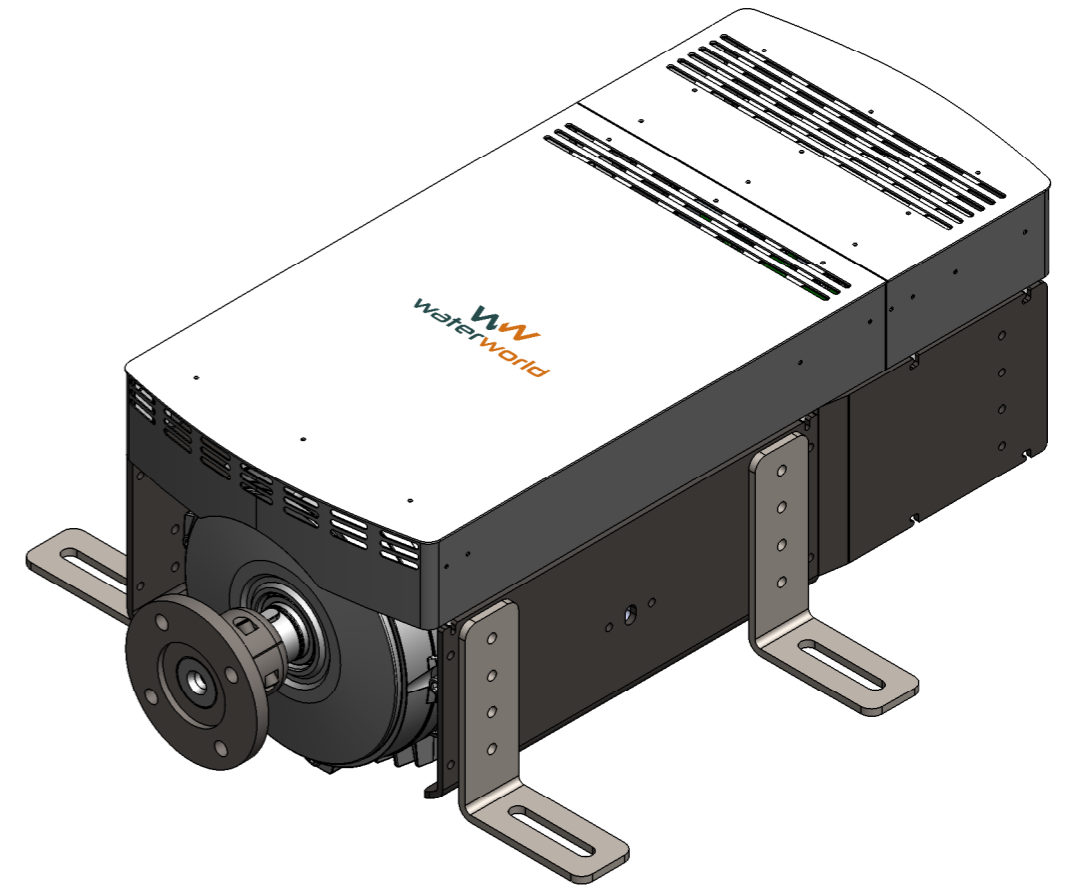

Aanzicht Zij

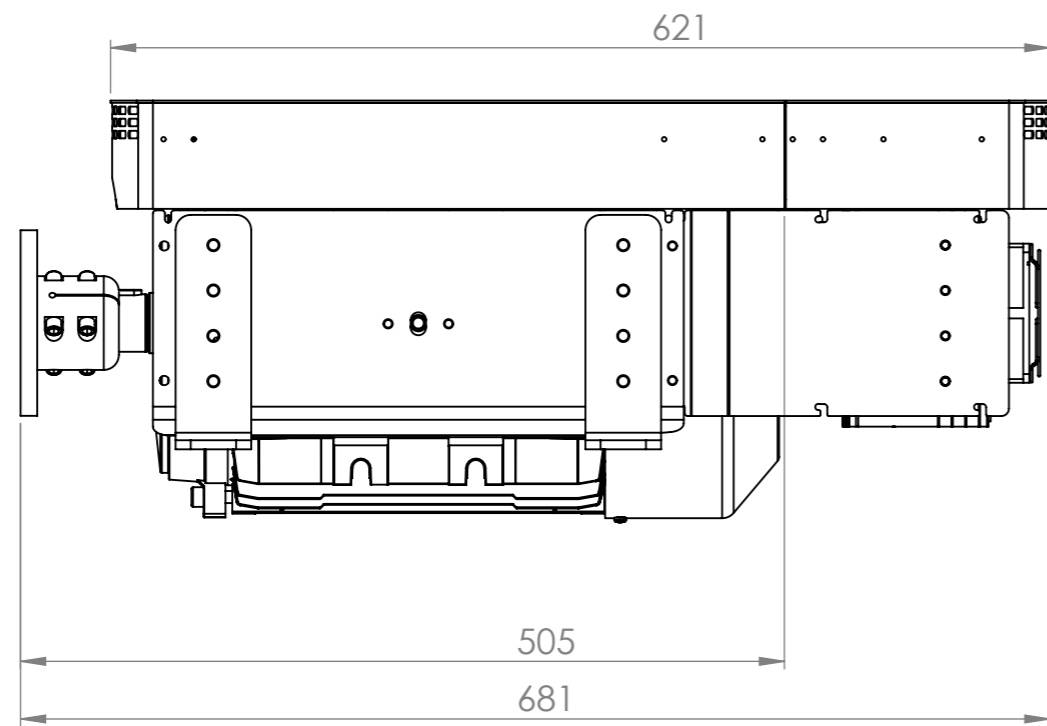

Aanzicht Voor

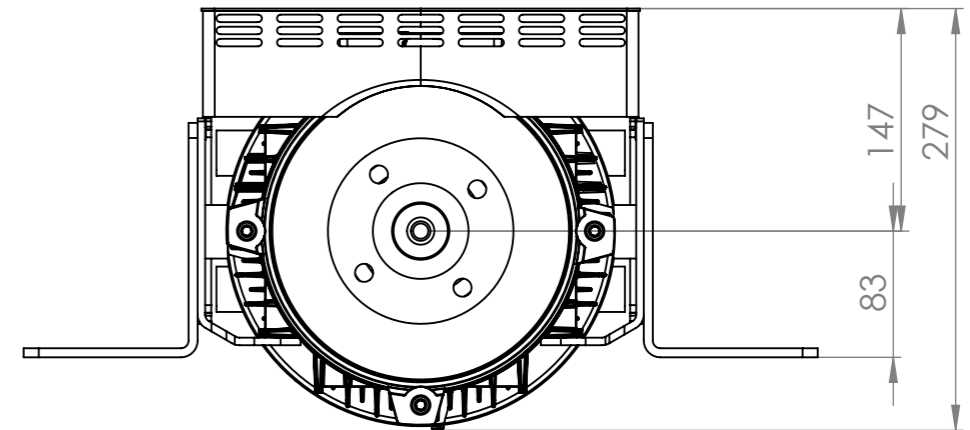

		UNLESS OTHERWISE SPECIFIED: DIMENSIONS ARE IN MILLIMETERS		DO NOT SCALE DRAWING	REVISION
		NAME	SIGNATURE	DATE	TITLE:
DRAWN	Boer		12-11-2018	<h1>WW MT 132</h1>	
CHK'D					
APPVD					
MFG					
Q.A.				DWG NO.	<h2>WW M132-000-04</h2>
				SCALE: 1:5	SHEET 1 OF 1

A3